

# OPERATION AND MAINTENANCE MANUAL

NOA Medical Industries Inc.



Elite Riser



# TABLE OF CONTENTS

Warnings.....	3
Reducing the Risk of Entrapment.....	4
Steps to Prevent Bed Fires.....	5
Specifications and Conditions.....	5
Physical Specifications.....	5
Locating Your Serial Number.....	5
Environmental Conditions.....	5
Electrical Specifications.....	5
Installation.....	6
Installing the Head and Foot Boards.....	6
Installing the Corner Mattress Retainers.....	7
Locating and Connecting the Pendant (Handset) Control.....	7
Securing the Power Cord.....	7
Bed Transport.....	8
Bed Operation.....	8
Operation of the Lock Out Pendant.....	9
Accessories and Options.....	9
In-Rail 4 Button and 6 Button Pendant.....	10
Sub Acute Care .....	10
Foot Board Control.....	10
Battery Backup.....	11
Servicing.....	11
Troubleshooting.....	12
MCL Control Box Socket Identification.....	12
Steps for Isolating Electrical Problems.....	13
Replacement of the Power Fuse.....	14
Bed Diagram.....	15
Parts List.....	16
Maintenance and Cleaning .....	16
Cleaning and Disinfecting the Bed.....	16
Periodic Inspection.....	17
Limited Warranty.....	18

Copyright ©2008 NOA Medical Industries, Inc. All rights reserved. Publisher reserves the right to make dimension or specification changes, or deletions, consistent with design trends, product improvements, or for reasons beyond our control. Publisher makes no warranties with respect to the accuracy or completeness of the contents of this manual. "Elite Riser", "V Riser", "AP Riser", "Twin Riser", and "Onyx" are trademarks of NOA Medical Industries, Inc.; other trademarks used in this document are property of their respective trademark holders.

## SPECIAL NOTES

WARNINGS/CAUTION NOTICES in this manual apply to hazards or unsafe practices, which could result in personal injury and/or property damage.

### NOTICE

The information in this document is subject to change without notice.

Check all parts for shipping damage before using. **DO NOT USE IF DAMAGED. ONLY USE AUTHENTIC NOA REPLACEMENT PARTS.** Contact NOA Medical Industries Inc. Customer Service 1 (636) 239-7600 and the freight carrier for further instruction.

This electric bed has been engineered to provide reliable operation.

This bed has been thoroughly tested and inspected prior to shipment.

### WARNINGS

**DO NOT OPERATE THIS EQUIPMENT WITHOUT FIRST READING AND UNDERSTANDING THIS MANUAL. IF YOU ARE UNABLE TO UNDERSTAND THE WARNINGS, CAUTIONS, OR INSTRUCTIONS, CONTACT A HEALTH CARE PROFESSIONAL OR A QUALIFIED TECHNICIAN BEFORE USING THIS EQUIPMENT. OTHERWISE INJURY OR DAMAGE MAY RESULT.**

- The correct bed height when unattended is based on the resident's knee to floor height, mobility, and cognitive level. For residents with good mobility and cognition, the top of mattress should be at a height so that the resident's feet are flat on the floor and the angle between the thighs and calves is 90 degrees. Bed height and the resident's abilities must be evaluated by a medical professional.
- If the resident's physical or mental state may lead to entrapment, the sleep deck should be left in the flat position when unattended.
- Do not use near explosive gases.
- Possible fire hazard when used with oxygen administering equipment other than nasal or masked type.
- When using nasal or masked type administering equipment, oxygen or air tubing **MUST** be routed and secured properly to ensure tubing does not become entangled, kinked, or severed during normal operation of the bed.
- Close supervision by a caregiver is necessary when this product is used near **CHILDREN OR PEOPLE WITH DISABILITIES**.
- **NEVER PERMIT ANYONE UNDER THE BED AT ANY TIME.**
- When operating/moving the bed always ensure that the individual utilizing the bed is positioned properly within the confines of the bed. **DO NOT** let any extremities protrude over the side or between the rails when performing these functions.
- After installation and before use, make sure all attaching hardware is securely tightened.
- Pendant cord must be routed and secured properly to ensure cord does not become entangled and damaged during normal operation of the bed.

## WARNINGS

(continued)

- Keep all moving parts free from obstruction i.e. blankets/sheets, heating blankets/pads, tubing, wiring, etc. which may get tangled around the bed, side rails, or legs during operation of the bed.
- Beds are equipped with locking casters. Casters should be locked at all times except when moving the bed or when operating sub acute care features.
- Do not roll the bed over abrupt thresholds with a resident in the bed.
- The mattress should be a healthcare type mattress to allow for proper bed articulation. The mattress must be properly sized to meet entrapment zone dimensional guidelines published by the FDA.
- The side rails are NOT intended and may NOT be used as a restraint. If necessary, a physician or healthcare professional should be consulted for other means of safe restraint.
- When using side rails, if excessive side pressure is exerted on them they can be deformed or broken. Do not use side rails as handles to move the bed.
- Never permit more than one person in/on the bed at any time.
- Body weight should be evenly distributed over the surface of the bed. The bed weight capacity is 500 pounds. This is the total weight of the resident/patient, mattress, bedding, head and foot boards, side rails and any other accessories.
- Do not lie, sit, or lean in such a way that your entire body weight is placed only on **RAISED** head or foot sections of the bed. This includes while assisting the user in repositioning or transferring in or out of bed.
- The bed is provided with an additional safety feature of a protective earth ground. The electrical cord should only be plugged into a **GROUND**ED 110/120V outlet. **DO NOT ALTER THE PROVIDED PLUG**. If the plug does not fit the existing outlet, a licensed electrician should install a correct outlet. Never operate the bed if it has a damaged cord or plug.
- Unplug the power cord when performing any maintenance on the bed.
- Do not open any actuator, pendant, or control box. If these units are opened the warranty is voided.

## REDUCING THE RISK OF ENTRAPMENT

The Hospital Bed Safety Workgroup (HBSW) in partnership with the FDA has recognized potential entrapment zones in hospital bed systems and has developed dimensional guidance to reduce the risk of entrapment. The FDA considers the term “hospital bed system” to encompass the bed frame and its components, including the mattress, bed side rails, head and foot boards, and any accessories to the bed.

The entrapment zones involve the relationship of components controlled by the healthcare facility or individual user. Compliance to the dimensional guidelines for reducing the risk of entrapment is primarily the responsibility of the healthcare facility or the individual user.

Anyone having any involvement with hospital bed systems should review and understand the FDA guidelines. These guidelines, entitled “Hospital Bed System Dimensional and Assessment Guidance to Reduce Entrapment - Guidance for Industry and FDA Staff,” are available at the FDA website.

## STEPS TO PREVENT BED FIRES

- Inspect the bed's power cord for damage.
- Connect the power cord directly into a wall-mounted outlet that is in good working order, with no cracks or chips. The plug should fit tightly into the outlet. The ground pin should be intact and secure.
- Do not connect the bed's power cord to an extension cord or to a multiple-outlet strip.
- Do not cover any power cord with a rug. Heat may build up or the cord may be damaged.
- Inspect the floor beneath the bed for buildup of dust and lint. Ask housekeeping to clean if necessary.
- Inspect the patient's bed controls, looking for signs of damage where liquids could leak in.
- Test the bed and its controls, including patient lockout features, to ensure that the bed can move freely in both directions without damaging any cords.
- Check monitors and other patient equipment for signs of overheating or physical damage.
- Keep linens and clothes away from power sources.
- Tell maintenance staff about any unusual sounds, burning odors, or unusual movement of a bed.
- If you suspect overheating, follow your facility's policy for fire safety and get the patient/resident to a safe area if necessary.

## SPECIFICATIONS AND CONDITIONS

**Note:** All dimensions and weights are approximate unless otherwise noted.

### Physical Specifications

	35" Width			39" Width		42" Width	
	76" Length	80" Length	84" Length	80" Length	84" Length	80" Length	84" Length
Sleep Deck Width	35"	35"	35"	39"	39"	42"	42"
Width w/Side Rails	40"	40"	40"	44"	44"	47"	47"
Sleep Deck Length	76"	80"	84"	80"	84"	80"	84"
Overall Bed Length*	80.5"	84.5"	88.5"	84.5"	88.5"	84.5"	88.5"
Weight	205 lbs.			225 lbs.		235 lbs.	

Safe Working Load\*\*: 500 lbs.  
 Deck Height Range: 8" - 28"  
 Maximum Back Angle: 70 degrees  
 Maximum Hip to Knee Angle: 45 degrees

\*O.A.L. includes both head and foot boards.  
 \*\*The Safe Working Load is the total weight, including the resident, mattress, bedding, head and foot boards, side rails, and other accessories evenly distributed on the sleep deck.

### Locating Your Serial Number

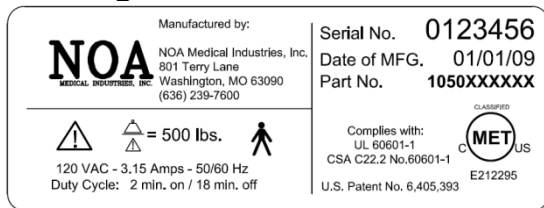

The serial number label is located at the foot end of the bed, under the mattress support deck, on the bed frame.

**Please have the serial number and model of the bed available when calling Customer Service 1(636) 239-7600.**

### Environmental Conditions

Ambient temperature range of 50°F to 104°F +10°C to +40°C  
 Relative humidity range of 30% to 75%  
 Atmospheric pressure range of 20.6 to 31.3 Inches of Hg.

#### Control Box and Actuators- IP44

Protected against dust and splashing water.

#### Pendants- IP66

Protected against dust and low-pressure jets of water.

### Electrical Specifications

Power: 110/120 V.A.C.  
 Frequency: 50/60 Hz  
 Current Rating: 3.15 Amps  
 Duty Cycle: 10% Max. (2 min. on/ 18 min. off)

# INSTALLATION

## Required Tools

- (1) - #2 Phillips Head Screwdriver

## Hardware Bag Contents

- (8) - ¼ - 20 x 1.5" Machine Screws
- (8) - ¼ - 20 Insert Cap Nuts
- (1) - Adjustable Cable Clamp
- (1) - #10-12 x ¾ Wood Screw

Upon receipt of your new bed, carefully inspect the bed and accessory components for any damage received in transit. Notify the NOA Customer Service at 1 (636) 239-7600 immediately if any product or component has been damaged or is missing from your shipment.

## Installing the Head and Foot Boards

On large orders, beds are shipped with transport legs inserted in the foot board mounting tubes. Remove and discard these legs and replace with foot board brackets. Insert brackets into the mounting tubes until snap buttons align in the holes as indicated below. Ensure that snap buttons are seated in the proper holes prior to bed use.

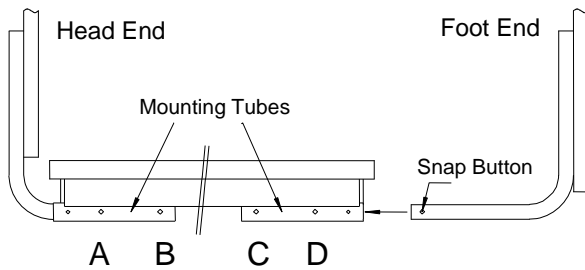

Bed Length	Head Board Bracket Hole	Foot Board Bracket Hole
76"	B	C
80"	B	D
84"	A	D

Normally the cap nuts are installed in the head and foot boards at the factory. If they are not installed at the factory insert the cap nuts provided in the hardware bag into the pre-drilled holes in the head and foot boards using a rubber mallet. If laminated on one side only, install the nuts on the laminated side of the board. Attach head and foot boards to the front face of the vertical bracket using the provided screws. Tighten all hardware.

Baseboard bumpers are factory installed on 76" and 80" beds. On 84" beds, the wire formed baseboard bumper must be installed in the head end caster base. Insert both ends of the bumper into holes as shown on the Bed Diagram. Press until the stop is reached.

## Securing the Power Cord

Approximately 8 feet of exposed power cord is provided with the bed. A cable tie has been supplied so that excess cord can be maintained and secured to the back of the head board. When securing the power cord, ensure that an adequate loose length is maintained to allow for the full range of motion of the bed.

## Installing the Corner Mattress Retainers

Corner Mattress Retainers (PN 3040025) should be installed at each corner of the bed to assist in maintaining proper alignment of the mattress during bed use. In order for the retainers to be effective, beds should be used in conjunction with a hospital grade mattress designed to allow for bed articulation. The mattress should be 6" thick by 35" wide with a length conforming to the sleep deck length (76", 80", or 84"). Mattress retainers should be installed prior to installation of any deck mounted side rails or assist bars.

1. Locate (2) ¼" holes at each bed corner in the outer angle of the head and foot deck. Insert each leg of the Mattress Retainer.



2. With the leg of each side of the Mattress Retainer positioned in the ¼" holes, rotate the Retainer towards the corner of the bed while slowly inserting the legs further into the holes.



3. When fully rotated, press the Mattress Retainer into position and then place the mattress on the rib-deck sleep surface. Check that all corners of the mattress are within the Retainers. A slightly compressed fit is desired.

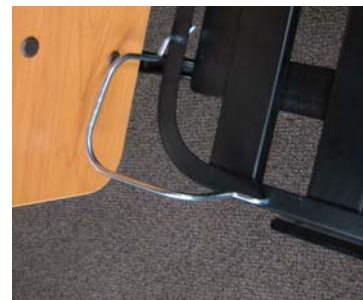

Ensure that the Retainers hold the mattress securely to prevent mattress slippage during head and foot deck articulation.

Install accessory components as per their instructions.

**Verify that there are no gaps between the mattress, head and foot boards, side rails, or any other accessories wide enough to entrap a resident's head, neck, or body.**

Your bed is ready for use. The bed should be located and casters locked while the bed is in its lowest position. Adequate spacing must be maintained between the wall and the bed to prevent damage to the bed or walls while raising or lowering the bed. Check to be sure that vertical movement of bed does not interfere with the power cord or plug.

## Locating and Connecting the Pendant (Handset) Control

For convenience the bed's pendant control may be located on either the left or right side of the bed.

As shipped from the factory the bed has an eight button pendant control plugged into a "Y" cable end on the resident's left hand side as standard. To relocate the pendant to the resident's right side simply unplug the pendant and plug it back into the other end of the "Y" cable on the opposite side of the bed.

Additionally as many as two pendants and one foot board control may be used on a single bed. See Bed Operation and Accessories and Options sections for additional information.

## Bed Transport:

The bed features a patented rolling base that allows it to be rolled or locked at any bed height. In order to lock the bed, activate the brakes located on the twin wheel casters at the foot and head of the bed. To roll the bed, disengage brakes. Activating caster brakes does not disengage bed functions.



### Caution

If casters are not locked swivel and wheel rotation can allow for bed motion with little or no resistance. This can result in loss of balance, fall, and personal injury. Ensure that the casters are locked to prevent any bed movement during resident transfer and/or treatment.



# BED OPERATION

## Bed Positioning

Bed functions are operated with either an 8 or 10 button pendant. A 10 button pendant with lock out feature is shown below. Button functions on the hand held pendant control are clearly identified with universal icons. The hand control is provided with an attached bracket for suspending the control from side rails or bed ends. PRIOR TO RAISING OR LOWERING THE BED AND/OR SIDE RAILS, CHECK TO ENSURE THAT THE CORD FOR THE PENDANT CONTROL HAS NOT BECOME ENTANGLED IN BED PARTS. THE CORD SHOULD BE KEPT CLEAR OF MOVING PARTS AT ALL TIMES.

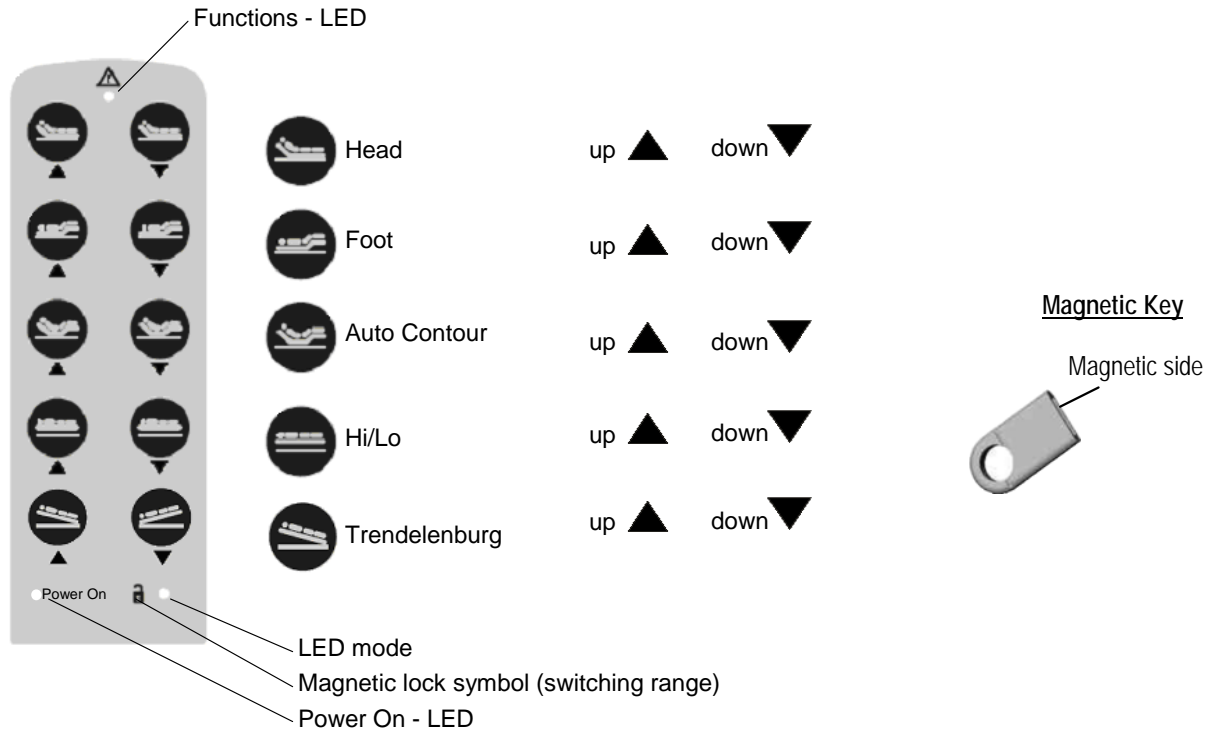

## Operation of the Lock Out Pendant

By passing the magnetic side of the magnetic key over the lock symbol, three modes can be released or locked.

- To put the Lock Out Pendant into operation, connect it to the MCL Control Box through the "Y" cable. The keyboard of the pendant is completely blocked (mode 1). The LED next to the lock symbol **does not glow**.
- Passing the magnetic side of the magnetic key once over the lock symbol releases the resident comfort functions (mode 2). The pendant will stay in this mode until the magnetic key is once again passed over the lock symbol. The LED next to the lock symbol **glows green**.
- Passing the magnetic side of the magnetic key once again over the lock symbol releases the HI/LO and Trendelenburg/Reverse Trendelenburg functions (mode 3). The LED next to the lock symbol **glows amber**.

While in mode 3 if no button is pressed after approximately 50 seconds of the pendant having last been actuated, mode 1 is reset.



Caution

Keep the Lock Out Pendant away from magnetic fields which could change the Pendant Mode.

## ACCESSORIES AND OPTIONS

### In-Rail 4 Button and 6 Button Pendant

The In-Rail 4 button and 6 button pendants are designed for easy customer installation in the Tall ½ Length Soft Touch Side Rail (PN 7540011XXX) and the Standard ½ Length Soft Touch Side Rail (PN 7540010XXX).

The In-Rail pendant may be used by itself or in conjunction with any of NOA's other pendants or foot board controls.

Once installed the In-Rail Pendant provides the resident with easy access when adjusting the bed for their personal comfort. The In-Rail Pendant comes equipped with either 4 buttons (PN 4040066) that controls the elevation of the head and foot, or 6 buttons (PN 4040067), which has the additional feature of bed height adjustment.

Because of the symmetrical design of the In-Rail pendant, it can be easily installed facing the outside of the Side Rail for access to the caregiver. When installed in this manner it allows a constant location that provides bed controls for the nursing care staff without searching for a pendant.

Since the In-Rail pendant is mounted in the rail, the damage to the pendant, due to stretching of the cord and dropping of the pendant, is virtually eliminated.

Six button In-Rail pendant (PN 4040066) shown being snapped into a standard height soft touch side rail (PN 7540010BLK).



#### Installation Instructions:

1. Snap the In-Rail pendant into the side rail. The In-Rail pendant may be mounted to face either the resident or the caregiver.
2. Plug the In-Rail pendant cord into either of two patch cords located at the head end of the bed on both the Left and Right sides.

**Note:** To prevent damage to the pendant cord the cord must be routed on the outside of the bedside rail. Do NOT route the cord between the side rail and the mattress.

## Sub Acute Care

The optional 10 Button Sub Acute Pendant (PN 4040059) or the optional Sub Acute Foot Board Control (PN 4040061) allows for Trendelenburg/Reverse Trendelenburg and Cardiac Chair Positioning.

**Trendelenburg/Reverse Trendelenburg Positioning** – This feature allows for the immediate adjustment of the bed into an incline of up to 17.5 degrees in either Trendelenburg or Reverse Trendelenburg positions. Trendelenburg positioning is controlled with two buttons located on the ten button pendant (see Bed Operation). To return to a normal horizontal bed position, either fully raise or lower the bed using the staff or resident pendant.

**Cardiac Chair Positioning** – The cardiac chair position can be achieved by positioning the bed in Reverse Trendelenburg and raising the head and foot sections to desired levels.

**Attention:** Ensure the head end of the bed is free to roll and at least 7 inches away from any obstructions before operating Trendelenburg or Reverse Trendelenburg features.

## Optional Foot Board Control

Optional Lock Out Foot Board Controls for both Standard (PN 4040060) and Sub Acute (PN 4040061) functions are available.



PN 4040060

### Connecting the Optional Foot Board Control Cable

1. Disconnect the terminator plug which is **either**:
  - Plugged directly into the MCL Control Box Port **or**
  - Plugged into the end of an extension cable located at the foot end of the bed as shown in the photo below.
2. Connect the Foot Board Control cable to the extension cable that is connected to the MCL Control Box:
  - Lift the locking cover on the extension cable connector.
  - Remove the terminator plug.
  - Connect the Foot Board Control Cable.



Terminator plug

**Note:** The Foot Board Port of the MCL Control Box must have **either** a foot board control cable **or** a terminator plug connected for any of the bed functions to operate. All beds are shipped from the factory with a terminator plug connected to the foot board port of the MCL Control Box.

## Optional Battery Backup

In the event of a power failure the control box is provided with a power down feature that enables lowering the bed without AC power. In order to use this feature the control box must have the optional MBK battery backup (PN 4040055) and Interconnect cable (PN 4040064).

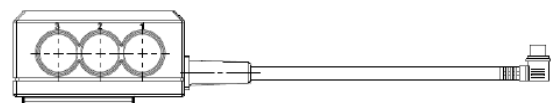

# SERVICING

## Troubleshooting

SYMPTOM	POSSIBLE CAUSE(s)	ACTION
No Power	<ol style="list-style-type: none"> <li>1. Bed is not plugged into A/C power.</li> <li>2. Cut/damaged power cord.</li> <li>3. Loose plug for pendant. Cut/damaged pendant cord.</li> <li>4. Actuator plug not connected.</li> <li>5. Blown fuse in MCL control box.</li> </ol>	<ol style="list-style-type: none"> <li>1. Check plug to receptacle.</li> <li>2. Check power cord for damage.</li> <li>3. Check pendant cord for damage.</li> <li>4. Check actuator connection to control box. Inspect actuator cord for damage.</li> <li>5. See Replacement of Power Fuse.</li> </ol>
Actuators operate, but the wrong movement occurs	<ol style="list-style-type: none"> <li>1. Actuators are plugged into the wrong ports on the Control Box.</li> <li>2. Cut/damaged pendant cord.</li> <li>3. Damaged/defective y-cable.</li> </ol>	<ol style="list-style-type: none"> <li>1. See MCL Control Box Socket Identification showing port /socket locations.</li> <li>2. Inspect pendant cord for damage.</li> <li>3. Unplug the y-cable and plug the pendant directly into the control box.</li> </ol>
One or more actuators do not function	<ol style="list-style-type: none"> <li>1. Foot Board Control Cable or Terminator Plug is not connected.</li> <li>2. Foot Board Controls in locked position.</li> <li>3. Loose or unplugged connection of actuator cord to control box.</li> <li>4. Cut/damaged actuator cord.</li> <li>5. Defective actuator.</li> <li>6. Defective control box.</li> <li>7. Defective terminator plug.</li> <li>8. Damaged/defective y-cable.</li> </ol>	<ol style="list-style-type: none"> <li>1. Check Foot Board Control Port to ensure either a cable or terminator plug is present.</li> <li>2. Press the unlock button on foot board control pad.</li> <li>3. Check actuator plug to control box.</li> <li>4. Inspect actuator cord for damage.</li> <li>5. Replace actuator.</li> <li>6. Replace control box.</li> <li>7. Replace terminator plug.</li> <li>8. Unplug the y-cable and plug the pendant directly into the control box port.</li> </ol>
Bed is not level when operating Hi/Low functions	<ol style="list-style-type: none"> <li>1. Bed bumped a wall or encountered other obstruction causing misalignment of actuators.</li> <li>2. Bed being operated in the mid-range loaded at one end.</li> <li>3. Damaged/defective y-cable.</li> </ol>	<ol style="list-style-type: none"> <li>1. Run bed to full up or full down position.</li> <li>2. Run bed to full up or full down position.</li> <li>3. Unplug the y-cable and plug the pendant directly into the control box port.</li> </ol>
The handset light turns red	<ol style="list-style-type: none"> <li>1. The terminator plug is in the wrong location.</li> </ol>	<ol style="list-style-type: none"> <li>1. Replace the handset. Place the terminator plug in the foot board control port on the MCL control box or in the foot board control disconnect cord. If the foot board control is connected, the terminator plug is not necessary and should be set aside.</li> </ol>

## MCL Control Box Socket Identification

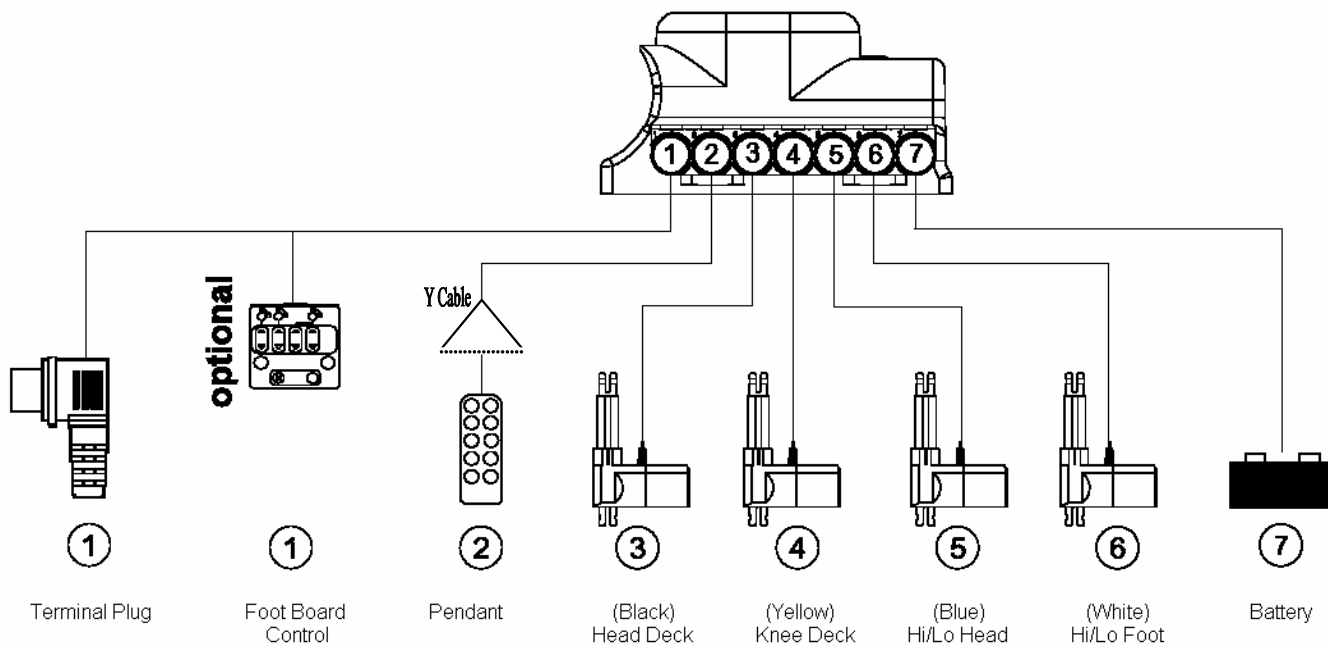

**Note:** The Foot Board Port of the MCL Control Box must have **either** a foot board control extension cable with a terminator plug or a foot board control or a terminator plug connected directly to the control box, for any of the bed functions to operate. All beds are shipped from the factory with a terminating plug connected to the foot board port of the MCL Control Box or at the end of an extension cable plugged into the MCL Control Box.

## Steps for Isolating Electrical Problems

1. Check all connections.
2. Exchange pendant with a known working pendant.
3. Exchange actuator plugs at known working control box ports.
4. Check actuator with a known working control box.

IF USE OF THIS TROUBLESHOOTING GUIDE DOES NOT CORRECT THE PROBLEM PLEASE CALL CUSTOMER SUPPORT AT 1 (636) 239-7600.

## Replacement of the Power Fuse

Replace the fuse with a T-4A type fuse only.

1. Unplug the power cord.
2. With help, turn the bed on its side.
3. Using a #1 Phillips screwdriver, remove 4 screws from the fuse access shaft cover (power cord strain relief).
4. Remove the connector cover plate from the control box, exposing wires and fuses.
5. Using needle nose pliers, grasp the fuse lengthwise on the metal ends.
6. Remove the fuse by pulling straight up from the fuse holder.
7. Using needle nose pliers, place the new fuse in the pliers, grasping the fuse on the ends. Insert the fuse into the fuse holder of the circuit board.
8. Replace the connector cover plate and 4 screws.
9. The power cord can now be plugged to function test the controls.

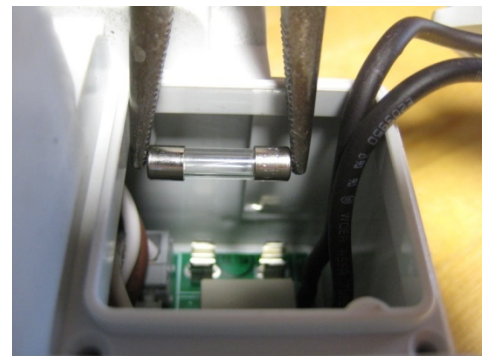
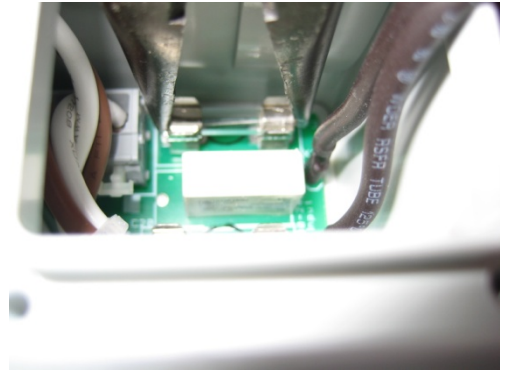

# Bed Diagram

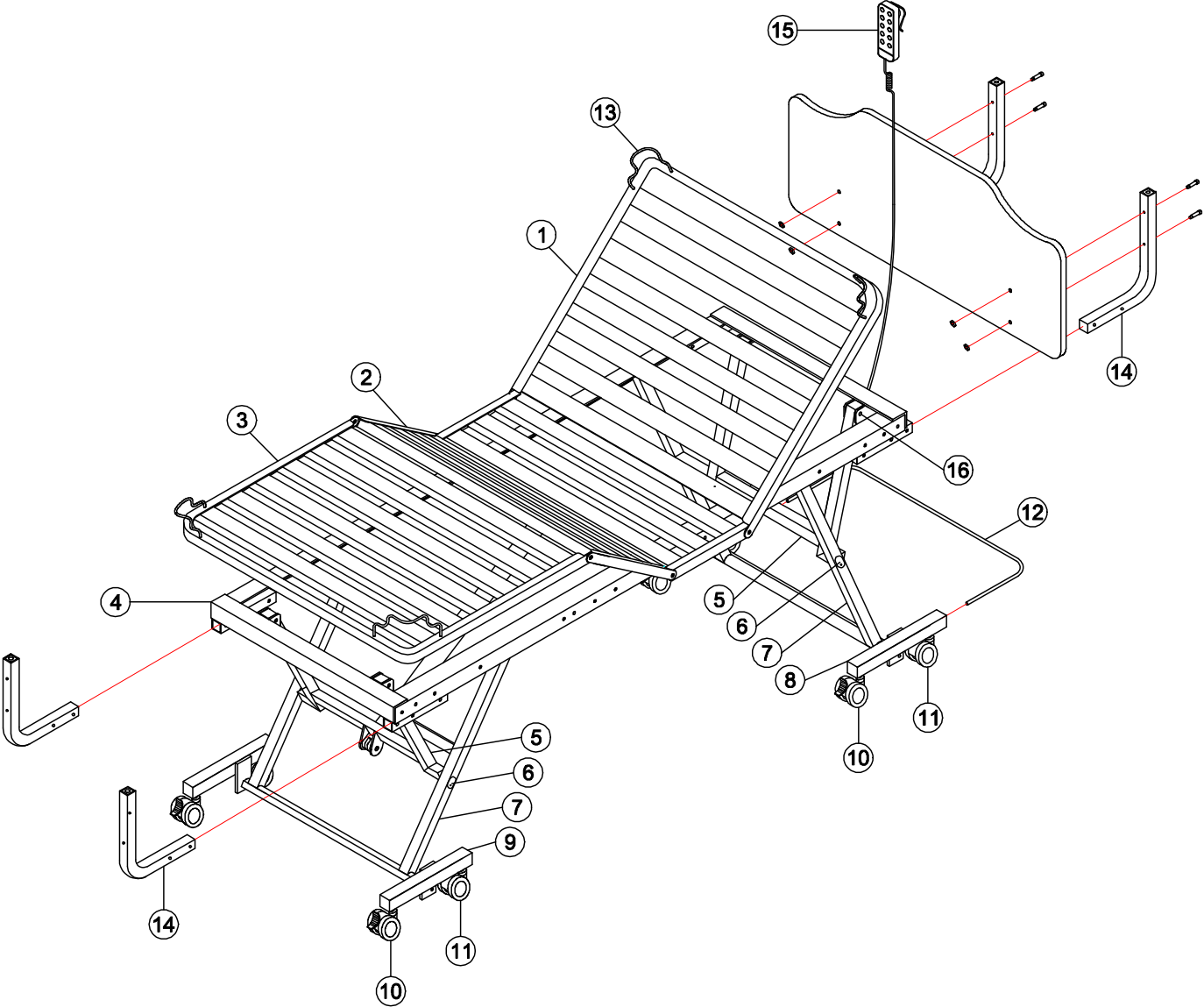

## Parts List

Item No	76"	80"	84"	QTY	DESCRIPTION
	35" - 1050000XXX-D	35" - 1050001XXX-D 39" - 1050003XXX-D 42" - 1050005XXX-D	35" - 1050002XXX-D 39" - 1050004XXX-D 42" - 1050006XXX-D		Bed Model
1	35" - 5240002XXX-D	35" - 5240002XXX-D 39" - 5250002XXX-D 42" - 5250012XXX-D	35" - 5240003XXX-D 39" - 5250003XXX-D 42" - 5250047XXX-D	1	Head Deck
2	35" - 5240004XXX-D	35" - 5240004XXX-D 39" - 5250004XXX-D 42" - 5250014XXX-D	35" - 5240004XXX-D 39" - 5250004XXX-D 42" - 5250014XXX-D	1	Knee Deck
3	35" - 5200044XXX-D	35" - 5200045XXX-D 39" - 5250045XXX-D 42" - 5250046XXX-D	35" - 5200045XXX-D 39" - 5250045XXX-D 42" - 5250046XXX-D	1	Foot Deck
4	35" - 5150000XXX-D 39" - 5150000XXX-D 42" - 5150004XXX-D	35" - 5150000XXX-D 39" - 5150000XXX-D 42" - 5150004XXX-D	35" - 5150000XXX-D 39" - 5150000XXX-D 42" - 5150004XXX-D	1	Bed Frame
5	5150002XXX	5150002XXX	5150002XXX	2	Elevation Arm
6	3050007XXX	3050007XXX	3050007XXX	4	Pivot Pin
7	5150001XXX	5150001XXX	5150001XXX	2	Elevation Leg
N.S.	3040013	3040013	3040013	2	Leg Lift Support
8	5240030XXX	5240030XXX	5240030XXX	1	Head Caster Base
9	5240005XXX	5240005XXX	5240005XXX	1	Foot Caster Base
10	4040009	4040009	4040009	4	Caster Twin Locking
11	4040008	4040008	4040008	4	Caster Twin Non-Locking
12	3040036	3040036	3040035	1	Baseboard Bumper
13*	3040025	3040025	3040025	4	Mattress Retainer
14*	1540001XXX	1540001XXX	1540001XXX	4	Head/Foot Board Bracket
N.S.	4040002	4040002	4040002	1	Actuator – Head
N.S.	4040085	4040085	4040085	1	Actuator – Foot
N.S.	4040036	4040036	4040036	2	Actuator – Elevation
15	4040057	4040057	4040057	1	Pendant
N.S.	4040062	4040062	4040062	1	Pendant Disconnect Cable
N.S.	4040065	4040065	4040065	1	Cap – Cable End
N.S.	4040069	4040069	4040069	1	Control Box
N.S.	4000222	4000222	4000222	12	Cotter Pin (Rue Clip)
16	4040016	4040016	4040016	12	Clevis Pin – 3/8" X 2-1/4"
N.S.	4000205	4000205	4000205	4	Washer, Flat – 3/8" SAE
N.S.*	4000197	4000197	4000197	8	Cap Screw – 1/4-20 X 1-1/2"
N.S.*	4010015	4010015	4010015	8	Cap Nut – 1/4-20
N.S.	4040025	4040025	4040025	1	Adjustable Cable Clamp
N.S.*	4000207	4000207	4000207	1	Screw - #10-12 X 3/4"

**Note:**

- Replace XXX with paint color of part (BLK for Black, BEI for Beige).
- N.S. – Not Shown
- \*Indicates part is shipped in hardware box (PN 7000043XXX).

**ATTENTION:** Only use authentic NOA Medical Industries, Inc. replacement parts.



## MAINTENANCE AND CLEANING

Maintenance and cleaning procedures should be performed at least once a year or as required.

### Cleaning and Disinfecting The Bed

1. ⚠ Unplug power cord before cleaning or performing maintenance on electric bed.
2. Do not submerge the pendant in liquid.
3. Do not steam or pressure wash the bed or any of its components.
4. Wipe down actuators, control box, and pendant with a damp, well wrung out cloth or with a disinfecting wipe.
5. Excess water or liquid may damage electrical parts and poses a shock hazard.
6. Wipe down the remainder of the bed with a disinfectant.
7. Allow the bed to dry completely before using.

### Periodic Inspection

1. Perform the procedure “**STEPS TO PREVENT BED FIRES**” listed in this manual.
2. Review “**REDUCING THE RISK OF ENTRAPMENT**” listed in this manual.
3. Review and inspect for compliance to the “**WARNINGS**” listed in this manual.
4. Check casters to ensure they lock, if applicable, and roll properly.
5. Inspect all bed components for damage or excessive wear.
6. Visually examine all welds for cracks.
7. Inspect the deck components for bending or damage.
8. Check the motor actuator shaft and its connections for bending, damage, or excessive wear.
9. Check actuator ends and its mounting hardware for bending or excessive wear.
10. Inspect all bolts and fasteners. (Do not over tighten bolts at pivot points.)
11. Check all cords for cuts or other damage.
12. Make sure all plugs are fully seated.
13. Make sure all cords are free of moving parts.

## LIMITED WARRANTY

The Manufacturer warrants to the original user (Customer) all products manufactured by the Manufacturer to be free from defects in material and workmanship under normal use and service for a period as specified below. If such a defect appears and Customer has given immediate written notification of same, the Manufacturer shall replace or repair such part at the Manufacturer's option. The Manufacturer will require the return of the defective part to establish the claim. The Manufacturer's obligation under this warranty shall be limited to said replacement and/or repair. Installation and freight costs for replaced or repaired items remain the responsibility of the Customer. This warranty does not cover failure due to negligence, accident, deliberate abuse, nor improper installation or maintenance. Modifications made to products (including modifications without the expressed written consent of the Manufacturer) shall void this warranty in its entirety. NO FURTHER WARRANTIES, EXPRESSED OR IMPLIED, INCLUDING, BUT NOT LIMITED TO, WARRANTIES OF MERCHANTABILITY OR FITNESS FOR A PARTICULAR PURPOSE NOT SPECIFIED HEREIN, ARE MADE BY THE MANUFACTURER, AND THIS WARRANTY SETS FORTH THE FULL EXTENT OF THE LIABILITY ARISING FROM THE MANUFACTURE, USE OR SALE OF THE PRODUCTS AND MATERIALS SOLD HEREUNDER. No allowances will be made for delays or loss of profit, nor for any other special, indirect or consequential damages or injuries, whether based on tort or contract.

Applicable warranty periods commencing from date of shipment from NOA are as follows:

- Welds ..... Lifetime
- Electrical components (excluding Handset Controls) ..... 4 years
- Mechanical components..... 4 years
- Handset Controls ..... 3 years
- Wood products ..... 1 year

**801 Terry Lane, Washington, Missouri 63090**

**Phone: (636) 239-7600 Fax: (636) 239-6900**

[www.noamedical.com](http://www.noamedical.com)